

SWING SOLUTIONS & APPLICATIONS



- "CURVED" PROFILE 125mm
- STEREON[®] PROFILE 100mm

INnovation**AL** Solutions

"CURVED" PROFILE 125mm

swing door with top and bottom clamp profile

technical specifications

| | |
|------------------------|--|
| Maximum Door dimension | 1,20m x 3,20m |
| Glass Thickness | 10-22mm |
| Maximum Glass Weight | 150Kg |
| Finishing | Natural anodized Satin anodized Powder coating |

INAL® glass swing door with top and bottom clamp profile without glass cuttings or drills (patented), with curved design external cover profile 125mm. A durable designed solution, up to 3,2 meters height, which provides extra safety and stability. Variety of glass applications (10mm-22mm), with three different sizes of heavy duty accessories according to the glass thickness. Available with lock mechanism in the bottom clamp for significant safety.

Available in do it yourself (DIY) or made to measure upon request.

system accessories

WITHOUT GLASS CUTTINGS OR DRILLS

1116 Side End Cap

1230 Upper Pivot

1200-01 "CURVED" Clamp Profile 125mm
INTERMETAL SA PATENT

PR200-19 "CURVED" Clamp Cover 125mm

1200-04 Internal Clamp Support

1220 Lower Bracket

1240 Lock Mechanism with Cylinder (Double Lock)

Available in DIY Kit

INTERMETAL SA PATENT

top pivot



floor spring



lock casing



weatherproofing



or any floor spring from our range Catalogue "Glass Accessories"

clamp profile sizes

Available in **three different sizes** according to the glass thickness:

1. Glass Thickness **10-12mm**
2. Glass Thickness **14-15-16mm**
3. Glass Thickness **20-22mm**

Special profiles upon request



cross section

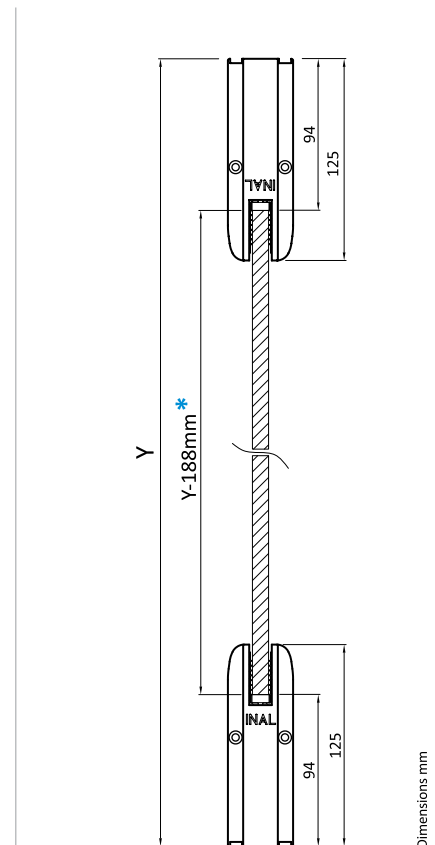

side end caps

PLASTIC SIDE END CAP



1116.10 for 10-12mm glass
1116.15 for 14-16mm glass
1116.20 for 20-22mm glass

top pivots

UPPER PIVOT ALUMINUM

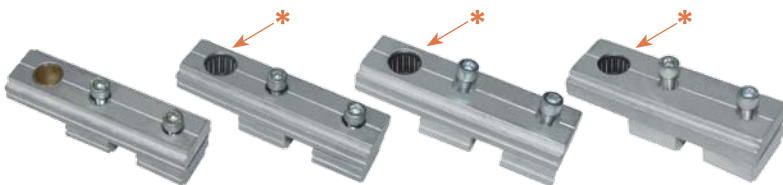

1230.10 for 10-12mm glass
1230.HD.12 Heavy Duty for 10-12mm glass
1230.HD.15 Heavy Duty for 14-16mm glass
1230.HD.20 Heavy Duty for 20-22mm glass

* With embedded bearing

brackets

LOWER BRACKET STAINLESS STEEL



1220.10 for 10-12mm glass
1220.15 for 14-16mm glass
1220.20 for 20-22mm glass

! Apply

THE SAME SYSTEM
FOR FIXED GLASS
PARTITIONS IN YOUR
APPLICATIONS



1204
Profile "CURVED"
for fixed glass

STEREON® PROFILE 100mm

swing door with top and bottom clamp profile

technical specifications

| | |
|------------------------|--|
| Maximum Door dimension | 1,00m x 3,00m |
| Glass Thickness | 10-22mm |
| Maximum Glass Weight | 120Kg |
| Finishing | Natural anodized Satin anodized Powder coating |

INAL® glass swing door with top and bottom STEREON® clamp profile 100 mm without glass cuttings or drills (patented).

A durable designed solution, up to 3 meters height, which provides extra safety and stability. Variety of glass applications (10mm-22mm), with three different sizes of heavy duty accessories according to the glass thickness. Available with lock mechanism in the bottom clamp for significant safety.

Available in do it yourself (DIY) or made to measure upon request.

system accessories

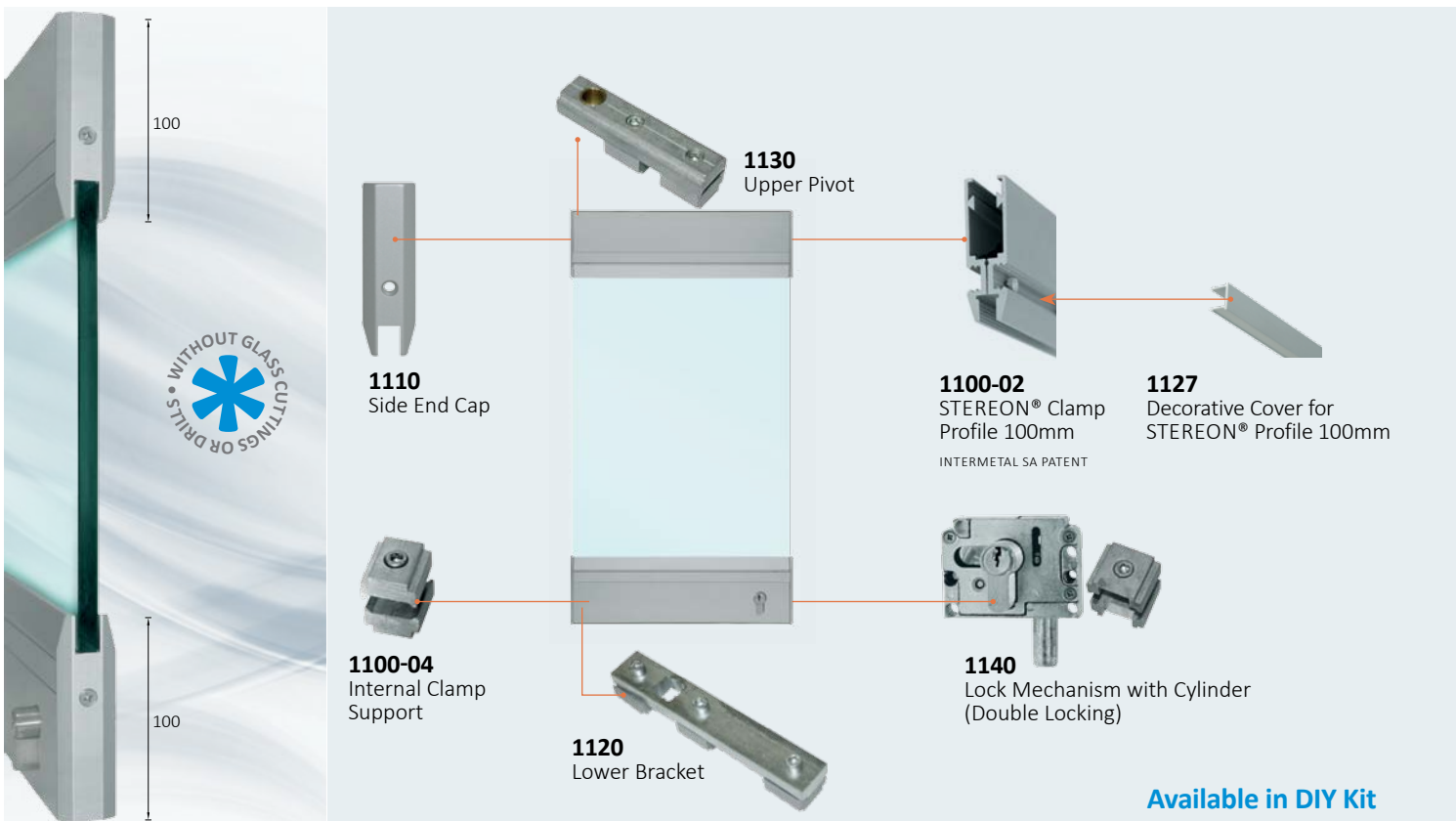

Available in DIY Kit

top pivot

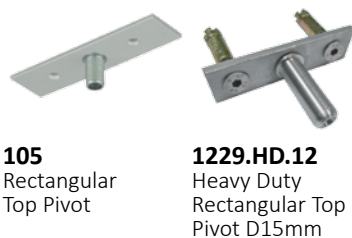

floor spring

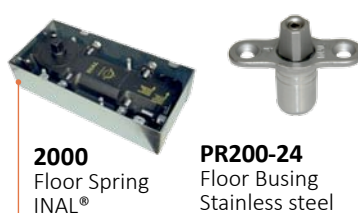

lock casing



weatherproofing



or any floor spring from our range Catalogue "Glass Accessories"

clamp profile sizes

Available in **three different sizes** according to the glass thickness:

1. Glass Thickness **10-12mm**
2. Glass Thickness **14-15-16mm**
3. Glass Thickness **20-22mm**

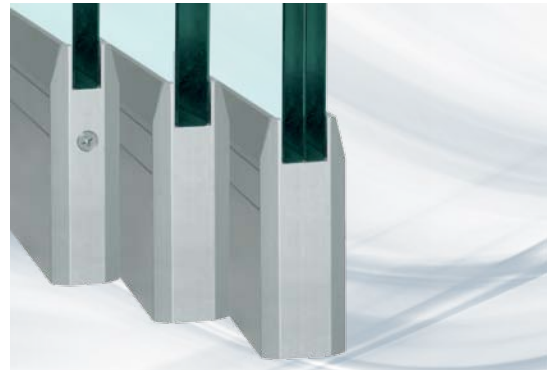

side end caps

ALUMINUM SIDE END CAP



1110.10
for 10-12mm glass



1110.15
for 14-16mm glass



1110.20
for 20-22mm glass

top pivots

UPPER PIVOT ALUMINUM



1130.10
for 10-12mm glass

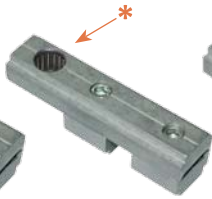

1130.HD.12
Heavy Duty
for 10-12mm glass

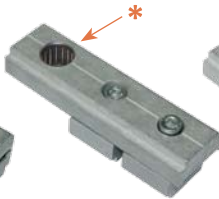

1130.HD.15
Heavy Duty
for 14-16mm glass



1130.HD.20
Heavy Duty
for 20-22mm glass

* With embedded bearing

brackets

LOWER BRACKET STAINLESS STEEL



1120.10
for 10-12mm glass



1120.15
for 14-16mm glass

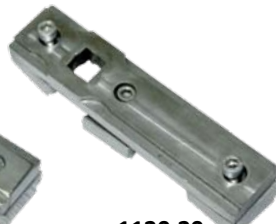

1120.20
for 20-22mm glass

cross section

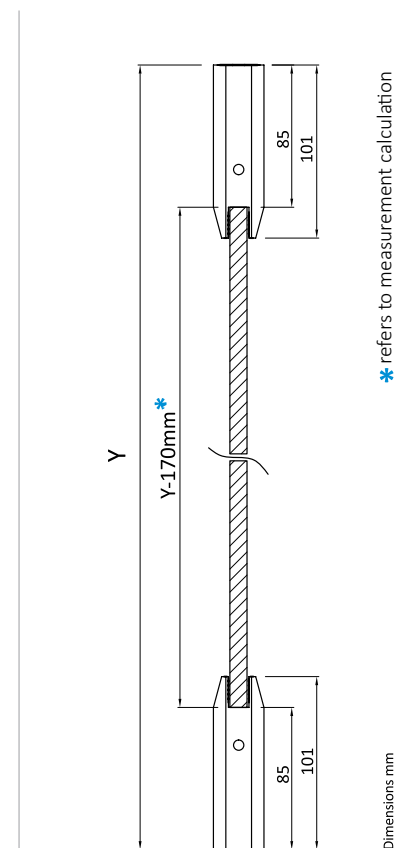

! Apply

STEREON® PROFILE
FOR THE FIXED GLASS
PARTITIONS OF YOUR
APPLICATIONS



1104
Profile for fixed glass
Stereon®

"CURVED" PROFILE 125mm

bottom with mechanical lock
& upper hinge

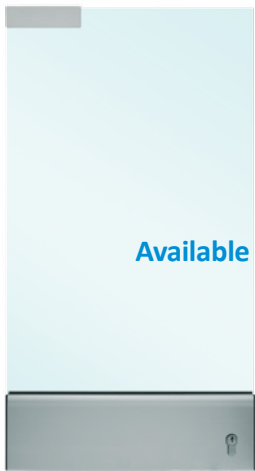

Available in DIY Kit

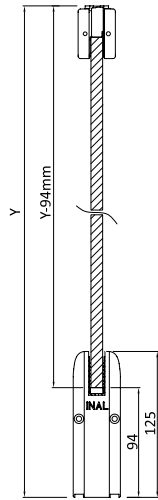

STEREON® PROFILE

bottom with mechanical lock
& upper hinge

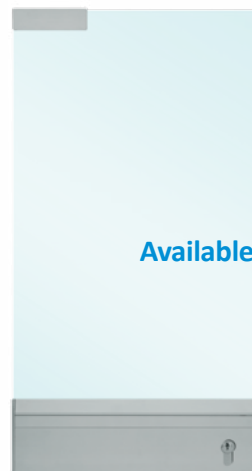

Available in DIY Kit

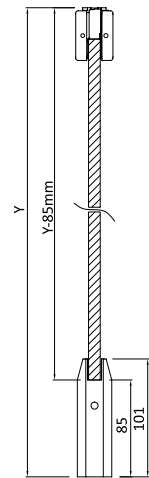

Dimensions mm

system accessories



system accessories

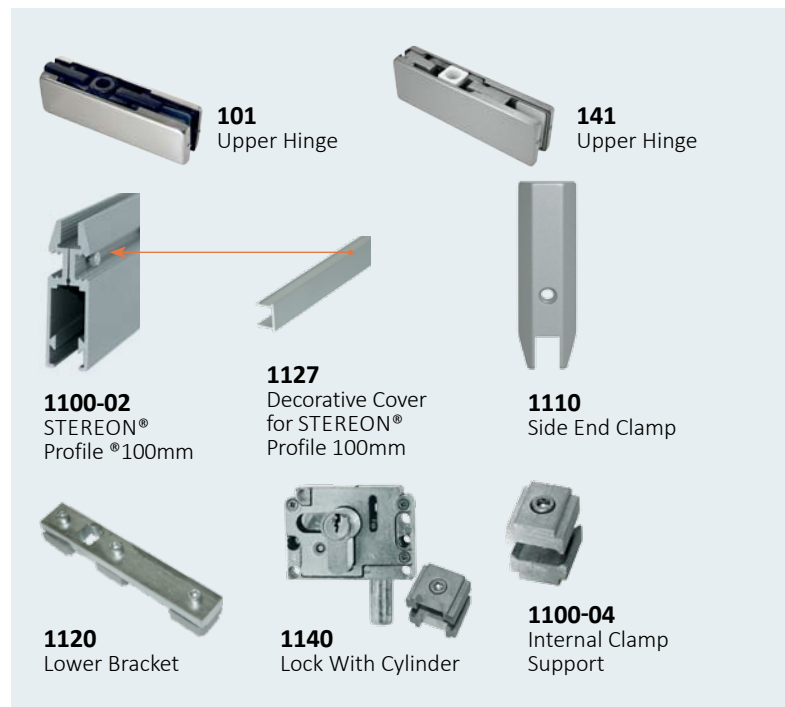

top pivot

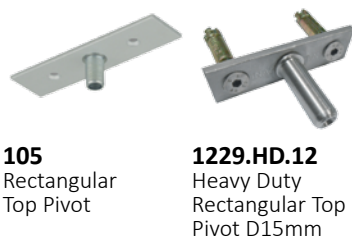

floor spring



lock casing



weatherproofing



→ or any floor spring from our range Catalogue "Glass Accessories"

electric locks

ONE WAY DOOR

295
Electromagnetic Lock
Operates with 12V DC



DOUBLE ACTION DOOR AL/R

298
Electromagnetic Lock
Operates with 12V DC



accessories for electric locks



296
Receiver
With Remote
Control



1700
Remote
Control



299E
Keyboard &
Card Reader



293
Card



294E
Transformer 12V DC



258
Transformer 12V DC
KIT



259
Transformer
12V DC KIT
with receiver
& remote
control



291C
Button
(Internal
use)



291B
Button
(Internal
use)



291A
Button
(Internal
use)

SWING SOLUTIONS & APPLICATIONS

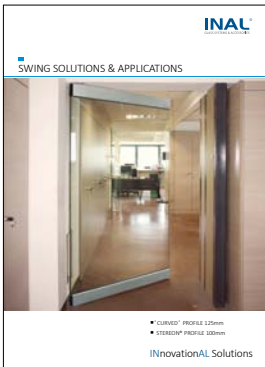

ALSO DOWNLOAD OUR PRODUCT CATALOGUES

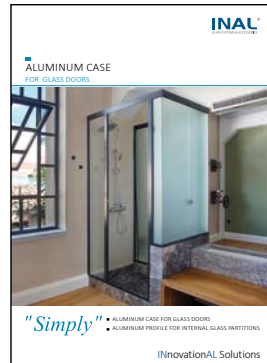
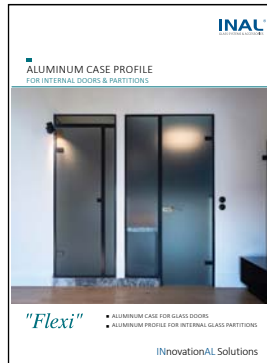
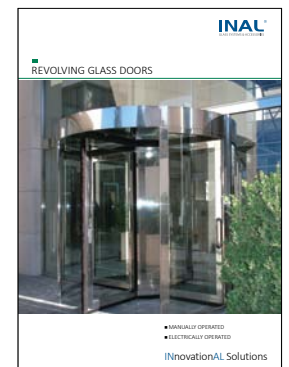

INnovationAL Solutions